

ALICE / IFIN-HH



- *Activities and achievements in the past year*
- *Remarks on additional activities*
- *2015-2017 perspectives*

HADRON PHYSICS DEPARTMENT

Light flavor hadron spectra at low p_T

Search for collective phenomena in high multiplicity pp

A-A, p-A, pp collisions

Similarities and differences

Centrality Selection

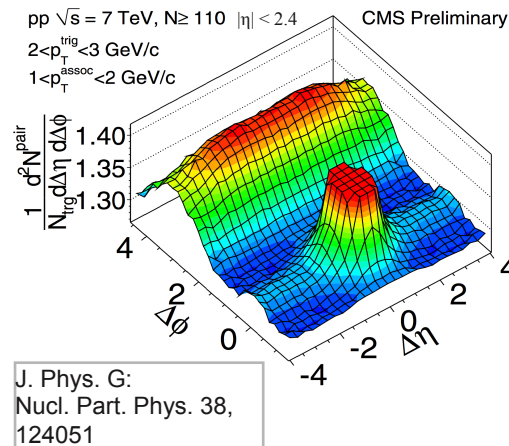
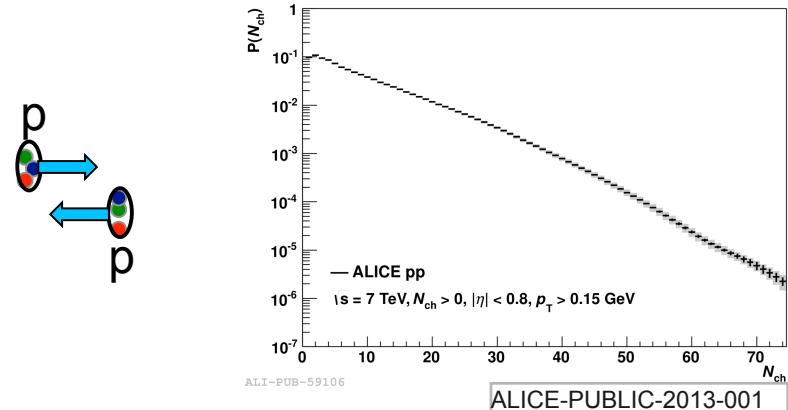
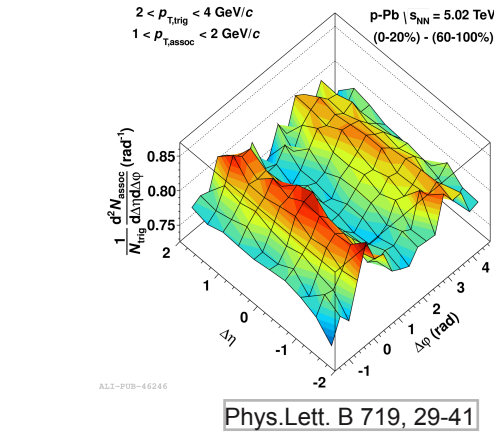
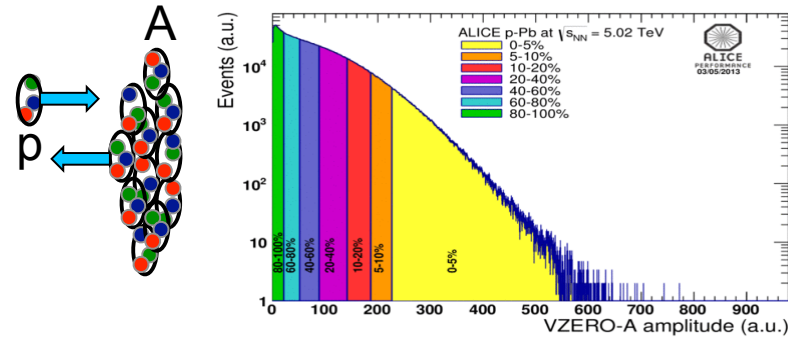
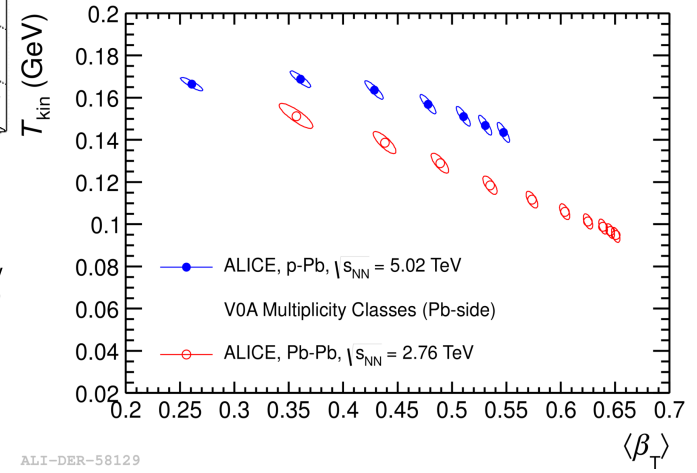
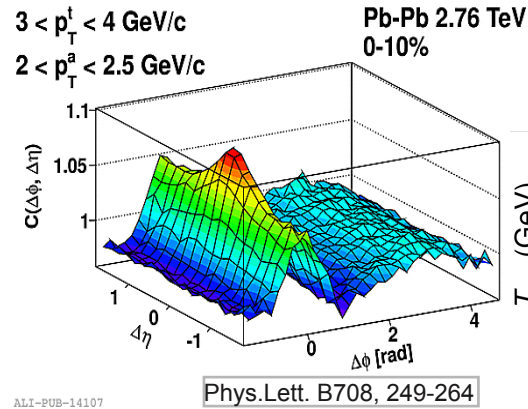
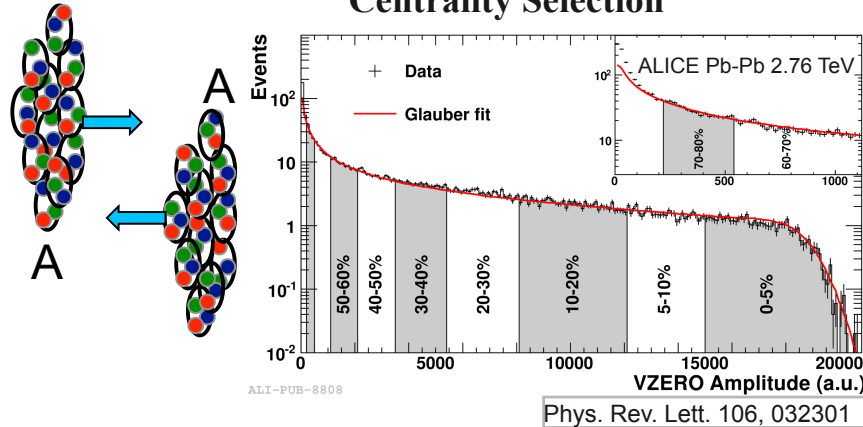

A-A, p-A, pp collision geometry

Glauber MC

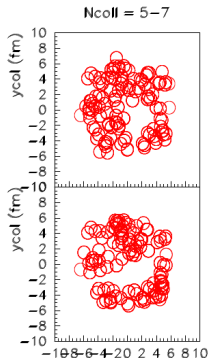
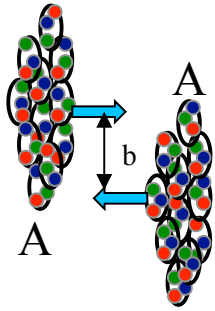

Pb+Pb 2.76 TeV, b=0

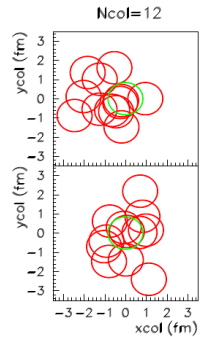
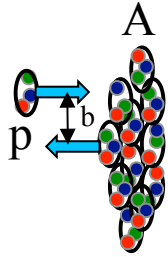
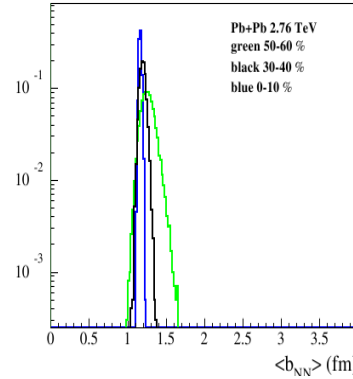
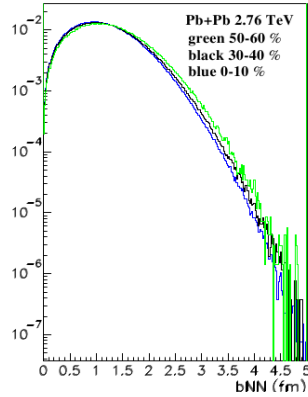

p+Pb 5.02 TeV, b=0

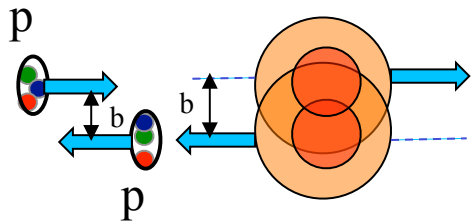
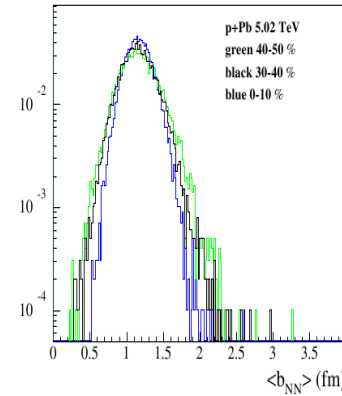
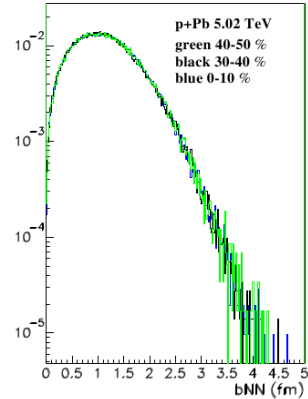

$$\rho(r) \propto \frac{1-\beta}{a_1^3} \exp\left(-\frac{r^2}{a_1^2}\right) + \frac{\beta}{a_2^3} \exp\left(-\frac{r^2}{a_2^2}\right)$$

$$O(b) \propto \frac{(1-\beta)^2}{2a_1^2} \exp\left\{-\frac{b^2}{2a_1^2}\right\} + \frac{2\beta(1-\beta)}{a_1^2 + a_2^2} \exp\left\{-\frac{b^2}{a_1^2 + a_2^2}\right\} + \frac{\beta^2}{2a_2^2} \exp\left\{-\frac{b^2}{2a_2^2}\right\}$$

$$\sigma_{in}(b, s) = 1 - e^{-kO(b)} \quad \sigma_{in} = 2\pi \int_0^\infty b \sigma_{in} db \quad \int_0^{w(b)} \psi(w) dw = \frac{1}{\sigma} \int_b^\infty d^2 b \sigma(b)$$

$$w(b) = \bar{n}(b) / \bar{N} \quad \bar{N} P(n) = \psi(z, \bar{N}) \quad z = n / N$$

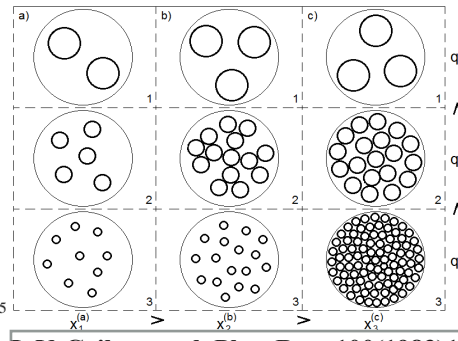
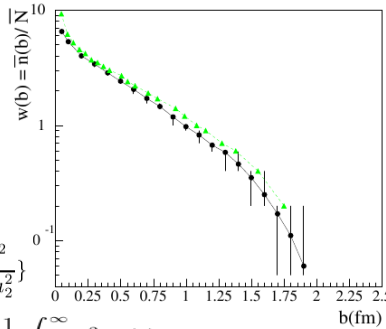

L.V. Gribov et al, Phys.Rep. 100(1983)1

@ 7 TeV increased MPI & rescattering
large energy transfer in a
collision volume of proton size

+
 $\lambda_{QGP} \sim 0.2 - 0.3 \text{ fm}$
close to thermalization

Does it follow an
explosion/expansion type dynamics?

pp, p-Pb, Pb-Pb comparison

Yield ratios as a function of p_T - multiplicity dependence

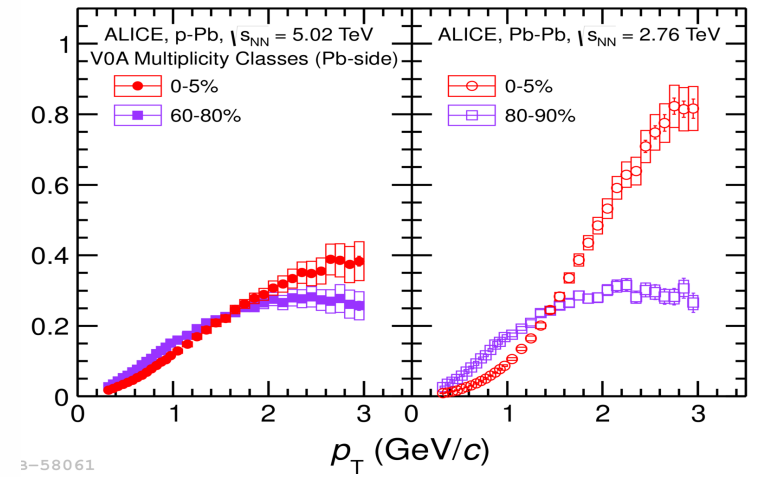
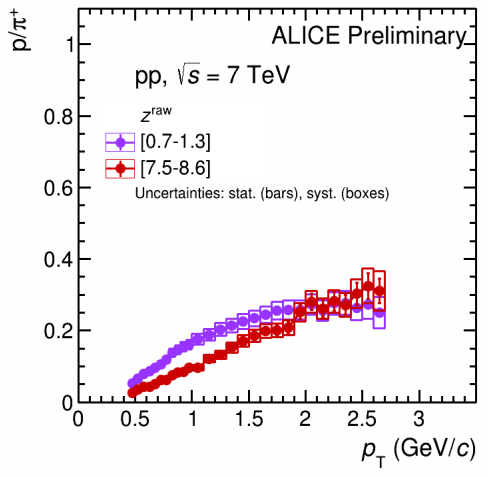
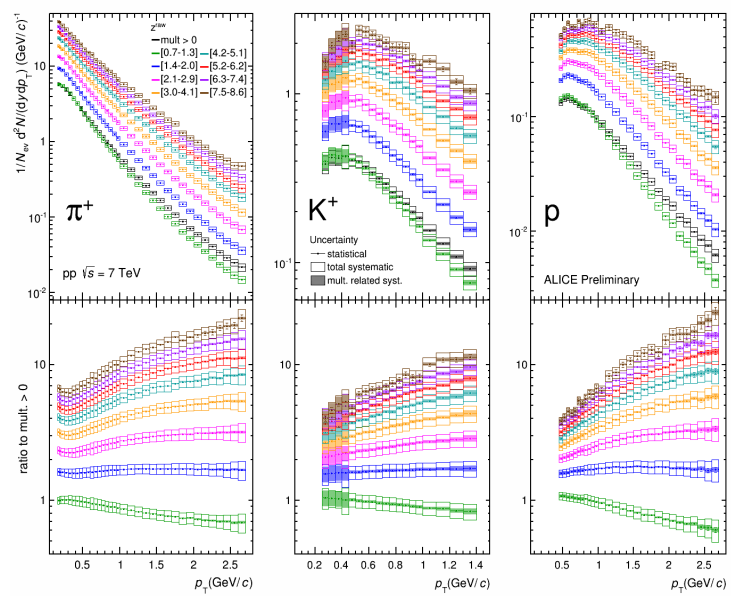

3-58061

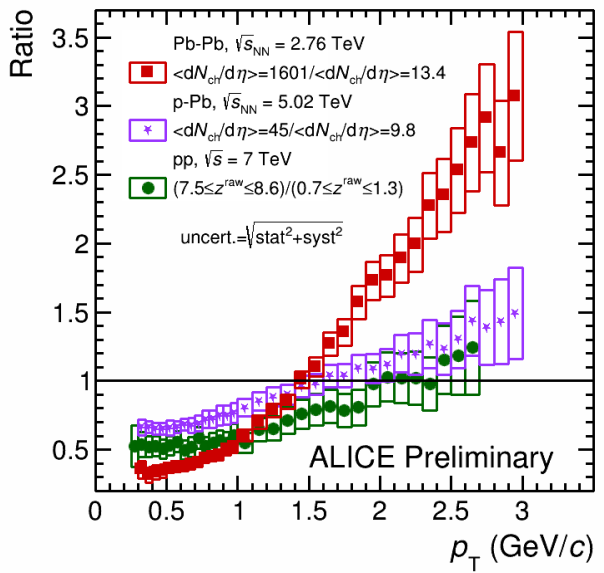

- the push of heavier particles towards larger p_T - present for all three systems
- the ratio to the lowest multiplicity bin for pp follows closely the p-Pb trend

pp, p-Pb, Pb-Pb comparison - Boltzmann-Gibbs Blast Wave fits

$$E \frac{d^3N}{dp^3} \sim f(p_t) = \int_0^R m_T K_1(m_T \cosh \rho / T_{fo}) I_0(p_T \sinh \rho / T_{fo}) r dr \text{ where } m_T = \sqrt{m^2 + p_T^2}; \beta_r(r) = \beta_s \left(\frac{r}{R}\right)^n; \rho = \tanh^{-1} \beta_r.$$

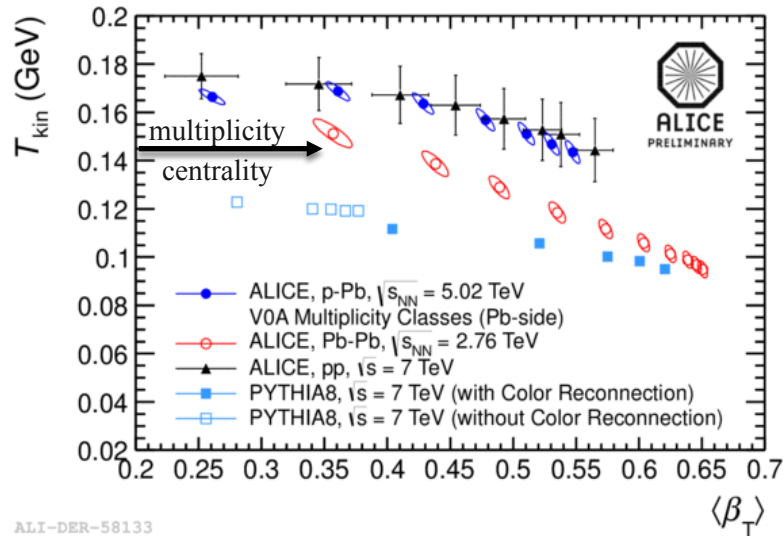

- similar trends in the $T_{kin} - \langle \beta_T \rangle$ correlation for pp and p-Pb while systematically the values for Pb-Pb are lower and higher, respectively, with increasing multiplicity
- $T_{kin} - \langle \beta_T \rangle$ correlation for pp is not reproduced by PYTHIA in absolute values; qualitatively PYTHIA-CR seems to indicate a similar trend as the experiment

ALI-DER-58133

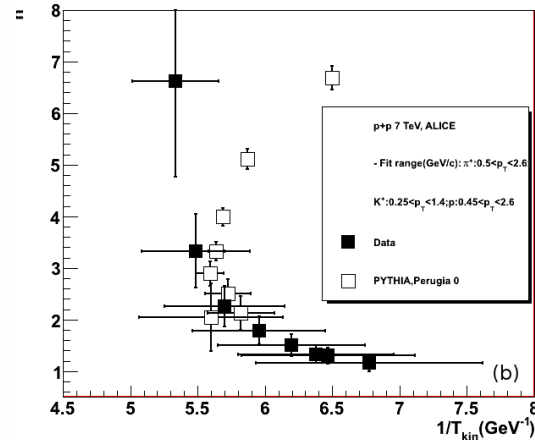
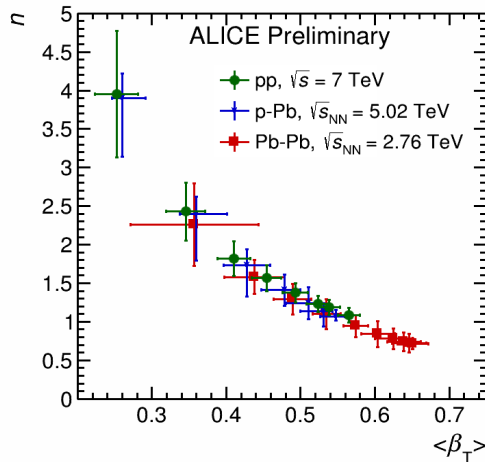

- $n - \langle \beta_T \rangle$ correlation
- similar for the three systems
- $n - T_{kin}$ correlation
- similar for pp and p-Pb
- for Pb-Pb T_{kin} has lower values
- towards high charged particle multiplicity expansion velocity approaches a linear dependence as a function of the position in the fireball(r)

Bjorken energy density
(preliminary estimates !)

- $N_{ch} = 130; |\eta| < 2.4$
- relative yields $|y| < 0.1$

V.Khachatryan et al., CMS Coll., Eur.Phys.J C72(2012)2164

- $N_{ch} |\eta| < 2.4 - |\eta| < 0.8$ PYTHIA
- => 5th mult. bin. of above presentation
- $b = 0.15$ fm
- $r_p = 1.081$ fm ($\sigma_{in} = 73.5$ mb)

- $\langle p_T \rangle$ - EPOS [K.Werner et al., arXiv:\[nucl-th\]13121233](#)

9.9 +/- 1.4 GeV/fm²

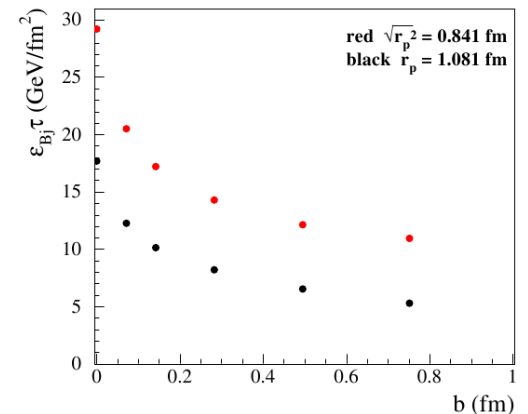

In progress

Extend the p_T range for kaons

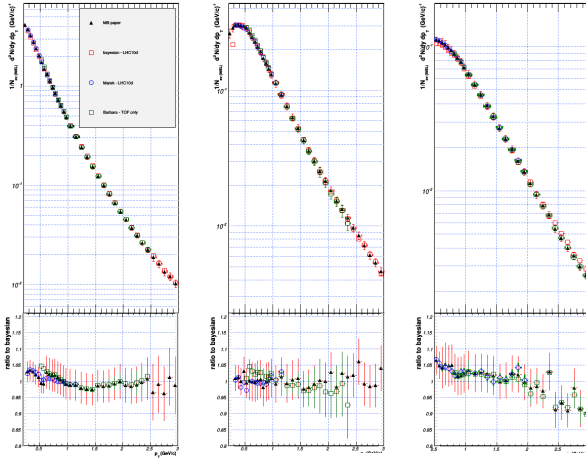

$$\varepsilon_{ij} = \frac{N_{id}(i; j)}{N(j)} \quad \text{Eff}_{PID} = \begin{pmatrix} \varepsilon_{\pi\pi} & \varepsilon_{\pi K} & \varepsilon_{\pi p} \\ \varepsilon_{K\pi} & \varepsilon_{KK} & \varepsilon_{Kp} \\ \varepsilon_{p\pi} & \varepsilon_{pK} & \varepsilon_{pp} \end{pmatrix}$$

$$(Eff_{PID})^{-1} \times (dN/dydp_T)_{raw}$$

Extended p_T range & pile-up studies charged particles

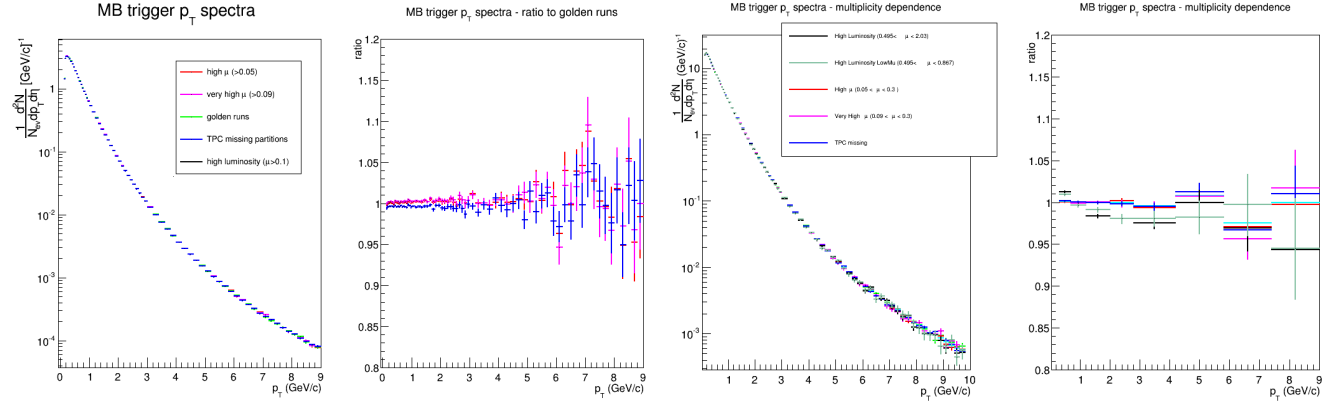

EPOS calculations

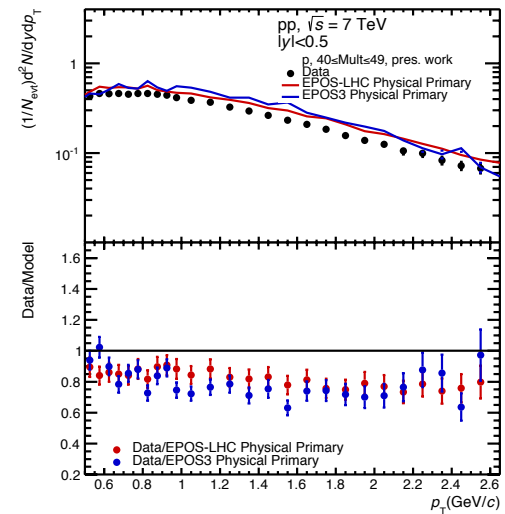
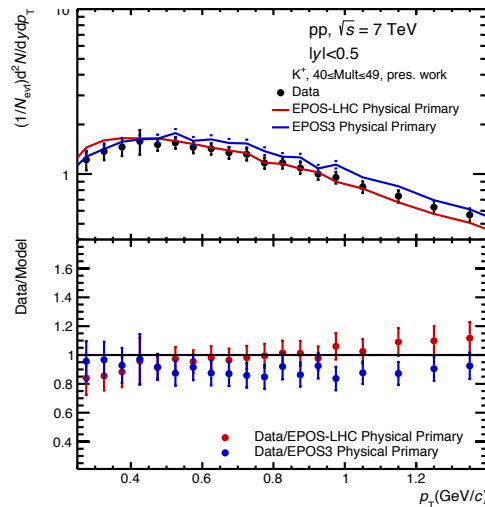
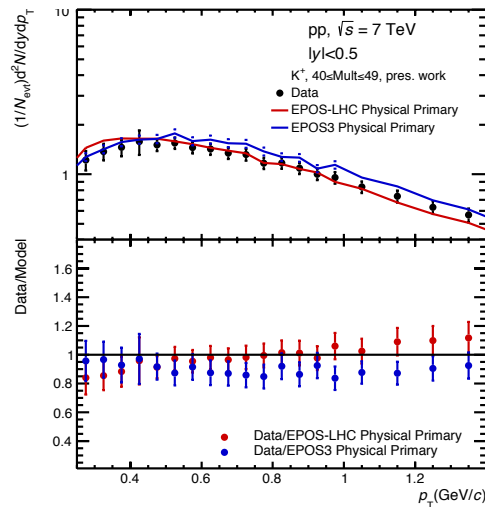

TRD-tracking

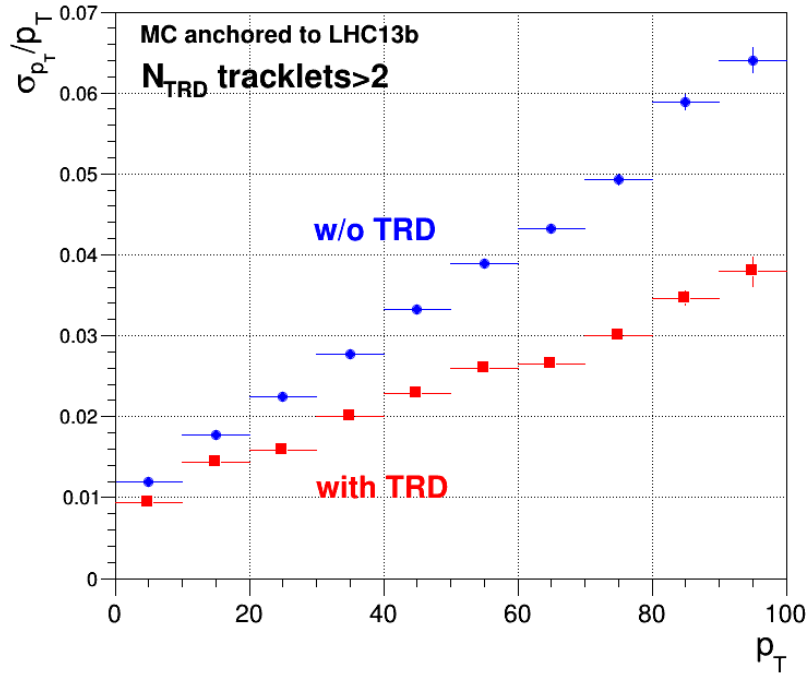

-
- High p_T trigger
 - On line tracking in Run3
 - Responsibility of tracking software coordination and development

*Including TRD in refit
may improve p_T resolution by factor ~ 2*

Computing

NIHAM

Tier2 component of ALICE GRID



NAF (Niham Analysis Facility)



Done Jobs

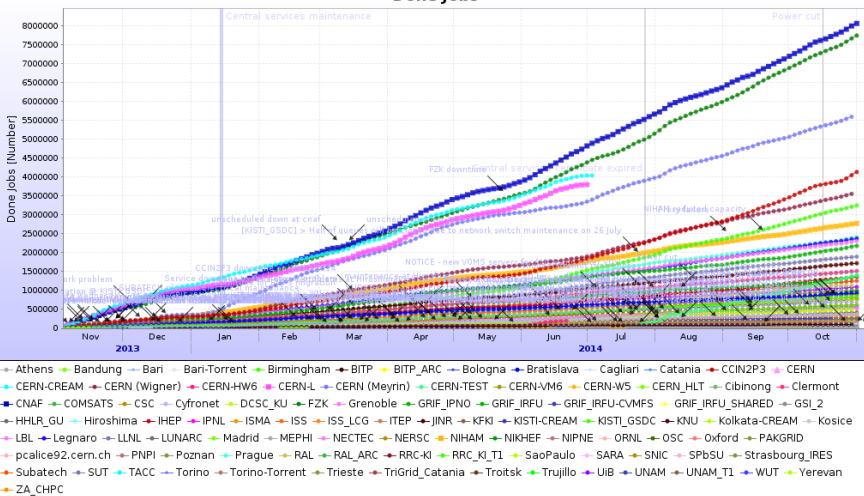

Software development for an efficient and flexible local data analysis

Analysis - Bayesian PID

- efficiencies, contaminations
- multiplicity dependence
- event shape global variables

DetLab upgrade

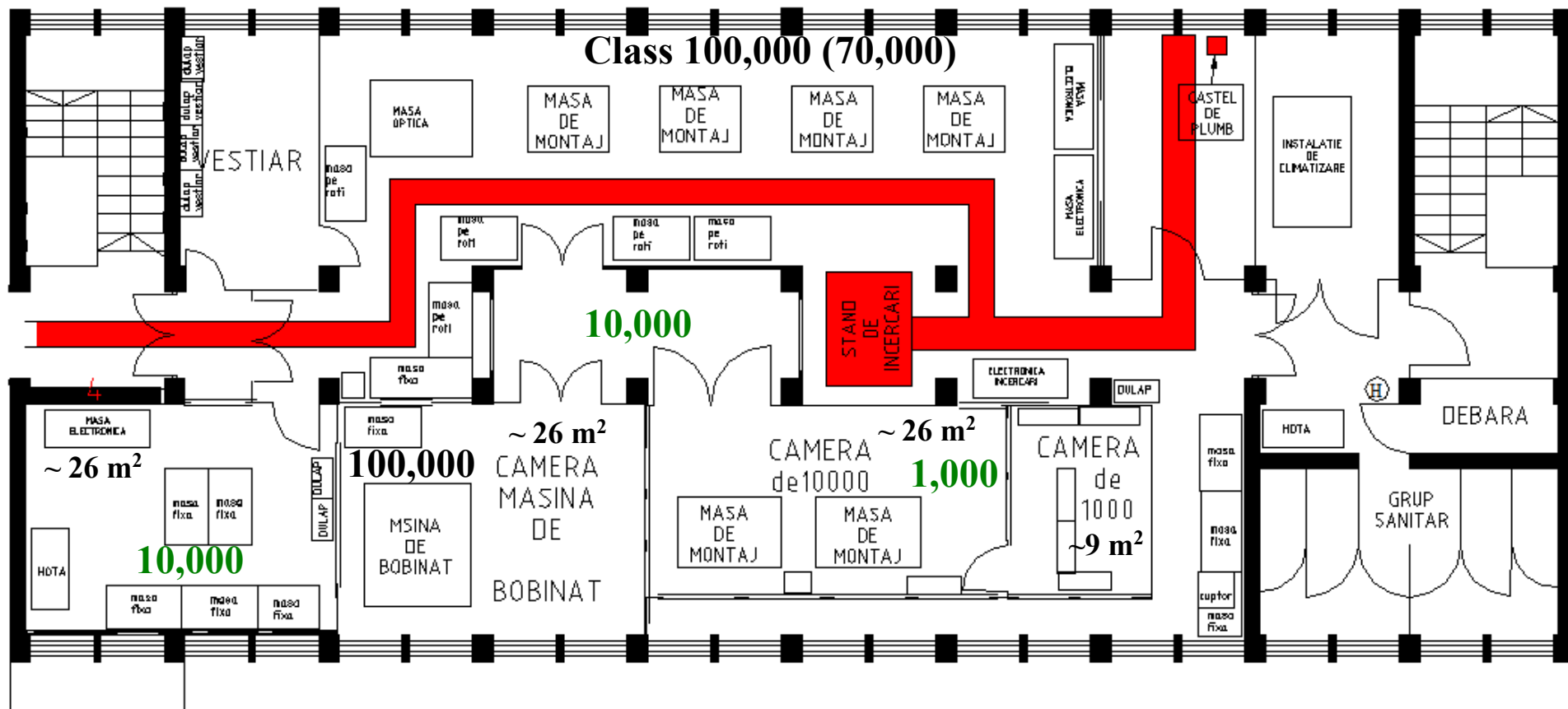

Papers and talks in the last year

Papers

- **Suppression of $\Upsilon(1S)$ at forward rapidity in Pb–Pb collisions at $\sqrt{s_{NN}} = 5.02$ TeV, ALICE Collaboration, Physics Letters B, <http://www.sciencedirect.com/science/article/pii/S0370269314007242>**
- **Performance of the ALICE Experiment at the CERN LHC ALICE Collaboration, Int. J. Mod. Phys. A 29 (2014) 1430044**
- **Beauty production in pp collisions at $\sqrt{s_{NN}} = 2.76$ TeV, measured using semi-electronic decays, ALICE Collaboration, PLB 738(2014)97**
- **Transverse momentum dependence of inclusive primary charged-particle production in pPb collisions at $\sqrt{s_{NN}} = 5.02$ TeV, ALICE Collaboration, Eur. Phys. J. C 74 (2014) 3054**
- **Azimuthal anisotropy of D meson production in Pb-Pb collisions at TeV, ALICE Collaboration, Phys. Rev. C 90 (2014) 034904**
- **Measurement of quarkonium production at forward rapidity in pp collisions at $\sqrt{s} = 7$ TeV, ALICE Collaboration, Eur. Phys. J. C 74 (2014) 2974**
- **Production of charged pions, kaons and protons at large transverse momenta in pp and Pb-Pb collisions at $\sqrt{s_{NN}} = 2.76$ TeV, ALICE Collaboration, PLB 736 (2014) 196**
- **Centrality, rapidity and transverse momentum dependence of J/Ψ suppression in Pb-Pb collisions at $\sqrt{s_{NN}} = 2.76$ TeV, ALICE Collaboration, Phys. Lett. B 743 (2014) 314-327**
- **Measurement of charged jet suppression in Pb-Pb collisions at $\sqrt{s} = 2.76$ TeV, ALICE Collaboration, JHEP03(2014)013**
- **J/Ψ production and nuclear effects in p-Pb collisions at $\sqrt{s} = 5.02$ TeV, ALICE Collaboration, JHEP02(2014)073**
- **Two and Three-Pion Quantum Statistics Correlations in Pb-Pb Collisions at TeV at the LHC, ALICE Collaboration, Phys. Rev. C 89 (2014) 024911**
- **Upgrade of the ALICE Inner Tracking System - Technical Design Report, ALICE Collaboration, J. Phys. G. 41 (2014) 087002**

Conferences

- **Transverse Momentum Distributions of Identified Particles in p-Pb Collisions at $\sqrt{s_{NN}} = 5.02$ TeV, J. Anielski for ALICE Collaboration, 14th International Conference on Strangeness in Quark Matter (SQM2013) Journal of Physics: Conference Series 509 (2014) 012106, doi:10.1088/1742-6596/509/1/012106**
- **Identified charged hadrons production in pp, p-Pb and Pb-Pb collisions at LHC energies with ALICE, Giacomo Volpe for the ALICE collaboration, ICNFP 2014, 3rd International Conference on New Frontiers in Physics, to appear in Conference Proceedings(EPJ Web of Conferences) 28 July – 6 August 2014, Kolymbari, Crete, Greece**
- **Identified particle production in pp, p-Pb and Pb-Pb collisions measured with ALICE at the LHC energies, Raúl Tonatiuh Jiménez Bustamante (for the ALICE collaboration), XXXVII Symposium on nuclear physics, Cocoyoc, México, January 6- 9 2014, to appear in Conference Proceedings volume of the IOP Journal of Physics: Conference Series**
- **Identified charged pion, kaon and proton production in pp, p-Pb, Pb-Pb collisions at LHC energies measured with ALICE, Peter Christiansen for the ALICE Collaboration, SPAATIND 2014, Nordic Conference on Particle Physics, January, 2- 7, 2014**
- **Identified particle production in p–Pb collisions measured with the ALICE detector Peter Christiansen, for the ALICE Collaboration, IS2013 — International Conference on the Initial Stages in High-Energy Nuclear Collisions Illa de A Toxa, Galicia, Spain, 8–14 September 2013, Nuclear Physics A 926 (2014) 264–269**
- **Light-flavour hadron production in p–Pb collisions measured with the ALICE detector at the LHC F. Barile, for the ALICE Collaboration, IS2013 — International Conference on the Initial Stages in High-Energy Nuclear Collisions, International Conference on the Initial Stages in High-Energy Nuclear Collisions, Illa de A Toxa, Galicia, Spain, 8–14 September 2013, Nuclear Physics A 926 (2014) 177–185**

Talks of group members

- Oral presentation at Quark Matter 2014, Darmstadt, Germany, 19-24 May 2014 :
Light flavor hadron spectra at low p_T and search for collective phenomena in high multiplicity pp, p-Pb and Pb-Pb collisions measured with the ALICE Experiment
C. Andrei for ALICE Collaboration, *Nucl.Phys.A 20024*, S0375
9474(14)00251-6 10.1016/j.nuclphysa.2014.08.002
- Invited lecture – Carpathian Summer School of Physics 2014 – Sinaia, Romania, July 13-26, 2014
Recent results and open questions on collective type phenomena from A+A to p+p collisions
M. Petrovici, C. Andrei, I. Berceanu, A. Bercuci, A. Herghelegiu, A. Pop <http://cssp14.nipne.ro>; will be published in an AIP Publishing Volume
arXiv:1411.0869 [nucl-ex] 2014

Internal notes

- Multiplicity dependence of transverse momentum spectra for positive pions, kaons and protons in p+p collisions at 7 TeV
C. Andrei, I. Berceanu, A. Bercuci, A. Herghelegiu, M. Petrovici, A. Pop
https://twiki.cern.ch/twiki/pub/ALICE/PWGLFPAGSPECTRAMultiplicityEventShap ePP7/InternalNote_Paper_Proposal_300414_mp.pdf
- Charged_part_density_discussion.pdf
- Charged_particle_density_discussion_v2.pdf
- Evaluation of the Bayesian PID in the central barrel of ALICE
C. Andrei, P. Antonioli, F. Noferini, R. Romita, A. Rossi, K. Schweda, J. Wiechula, J. Wilkinson
<https://aliceinfo.cern.ch/Notes/node/310>

Presentations at ALICE internal meetings

- 7 presentations in Spectra-PAG, PID-PAG, PWG-LF, PWG-PP, Physics Forum and ALICE Physics Week
- 1 CWG6 & CWG7 joint meeting
- 3 TRD weekly meetings
- 2 PWG-PP

Further activities

RPC – test lab

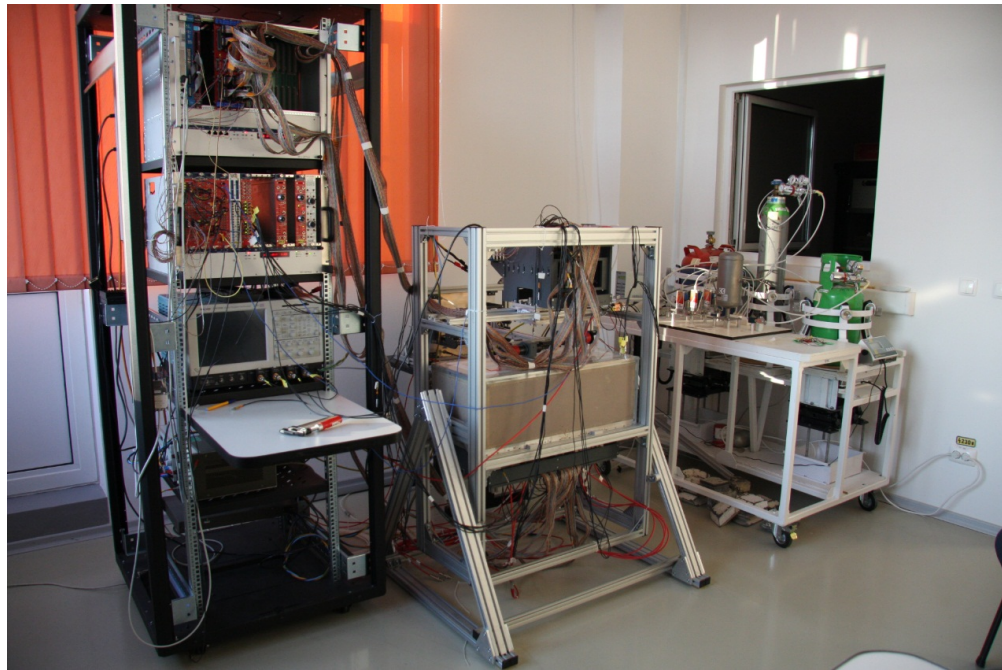

TRD – test lab

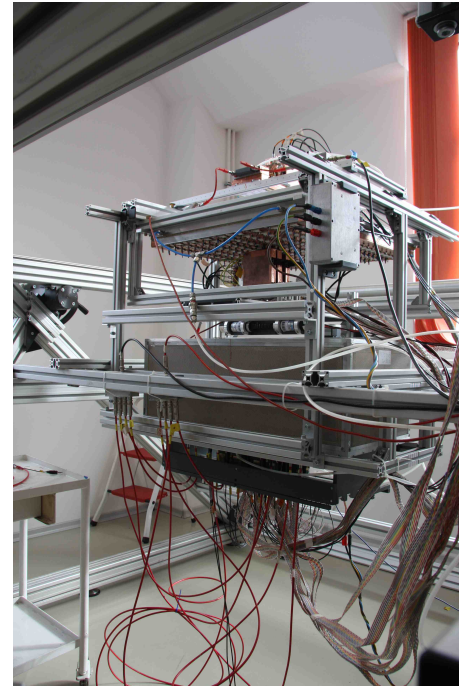
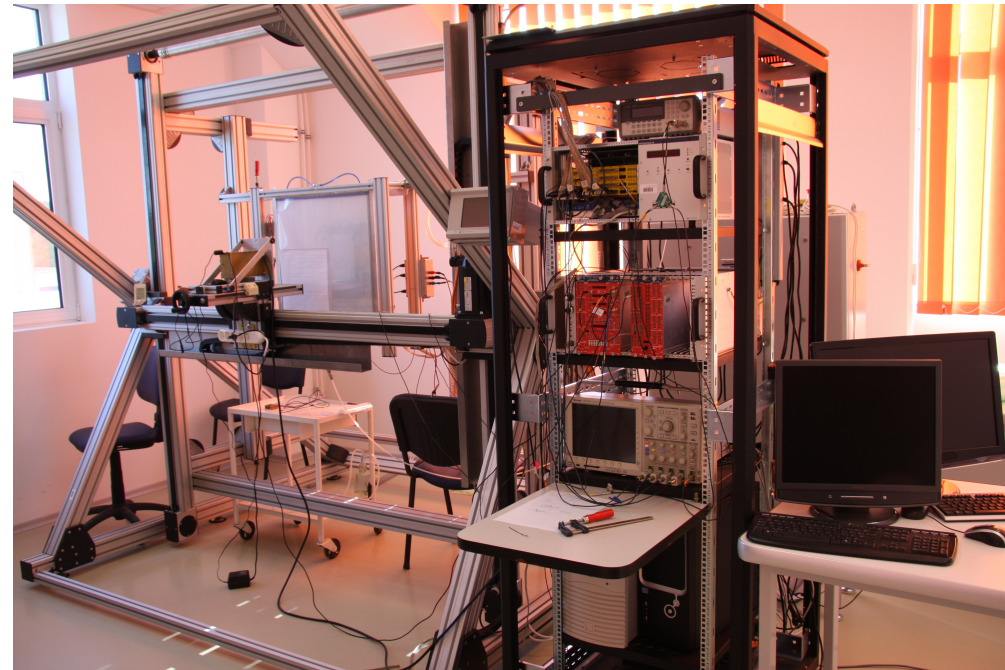

FASP_V_02

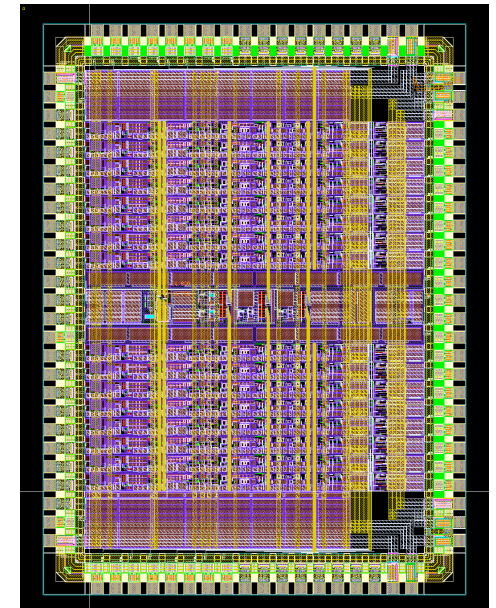

Outreach

Booklet

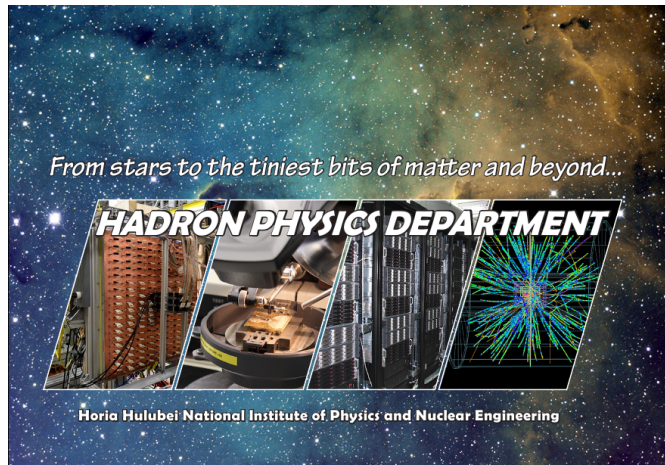

Magic cubes

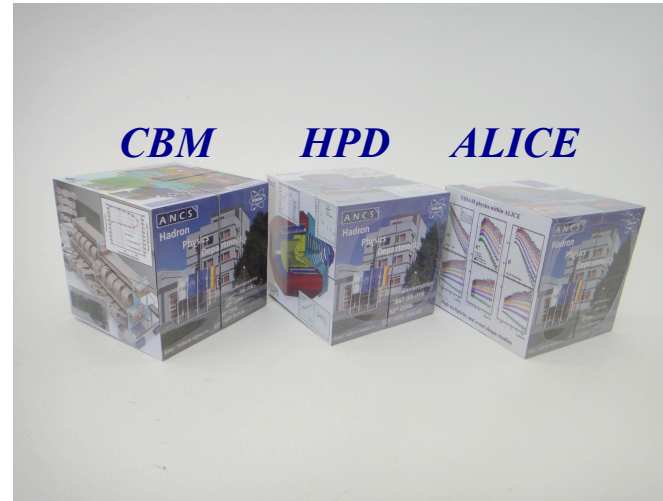

Movie

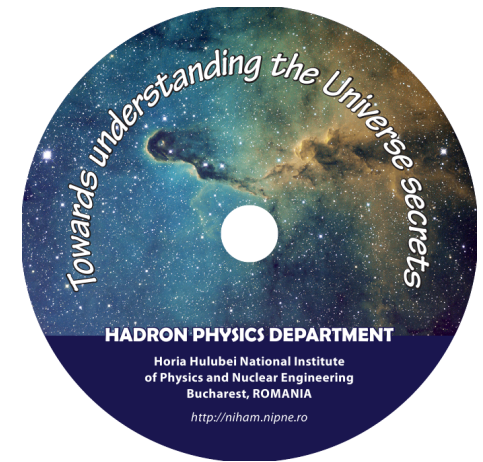

2014

- The 65th anniversary of IFA-IFIN-HH
- The 60th anniversary of CERN
- The 15th anniversary of ALICE membership
- The 10th anniversary of CBM membership
- The 10th anniversary of DetLab of HPD

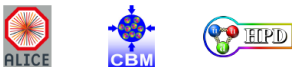
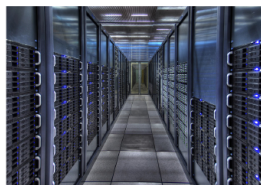
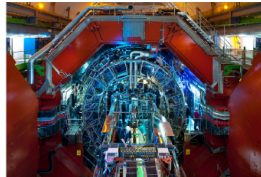

- Numerous visits of students, local and foreign delegations
- On the occasion of CERN 60th anniversary, IFIN 65th anniversary:
- Presentation at special event organized on the occasion of CERN 60th anniversary
July 19, 2014 – Sinaia - with the participation of Rolf Heuer - CERN DG
- Presentation - September 26 – Bucharest - with the participation of Livio Mapelli, head of Physics Division at CERN
- Posters
- Update of HPD web page - <http://niham.nipne.ro>

ALICE-TPC upgrade

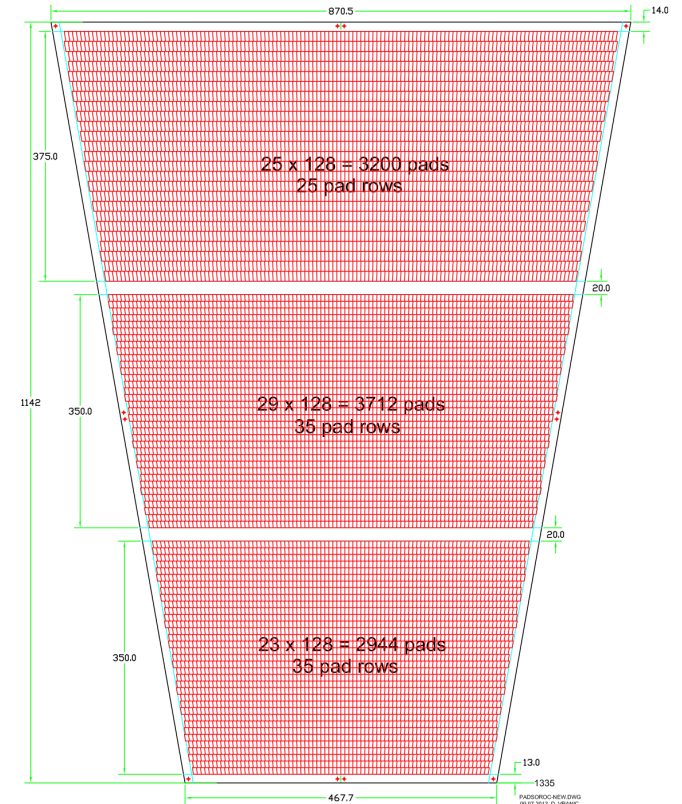
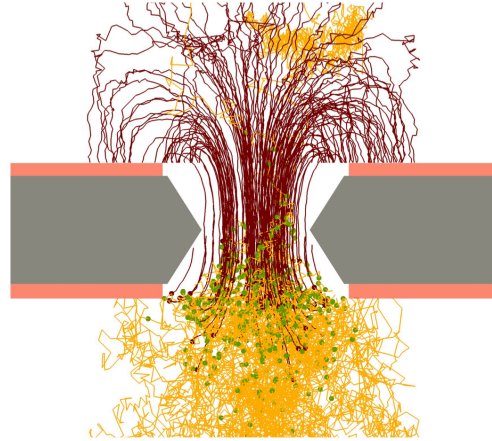
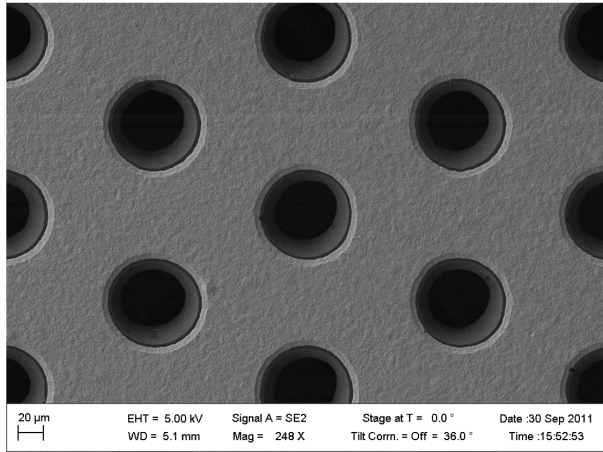
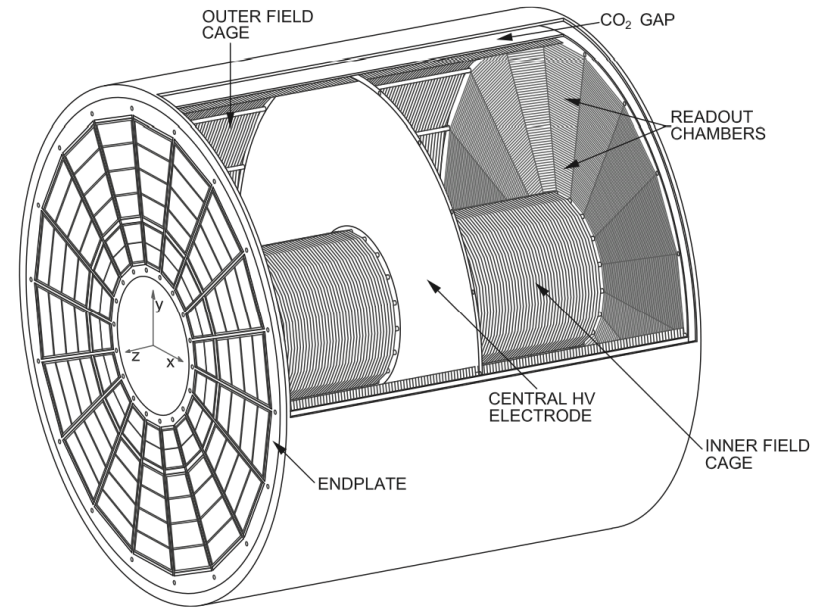
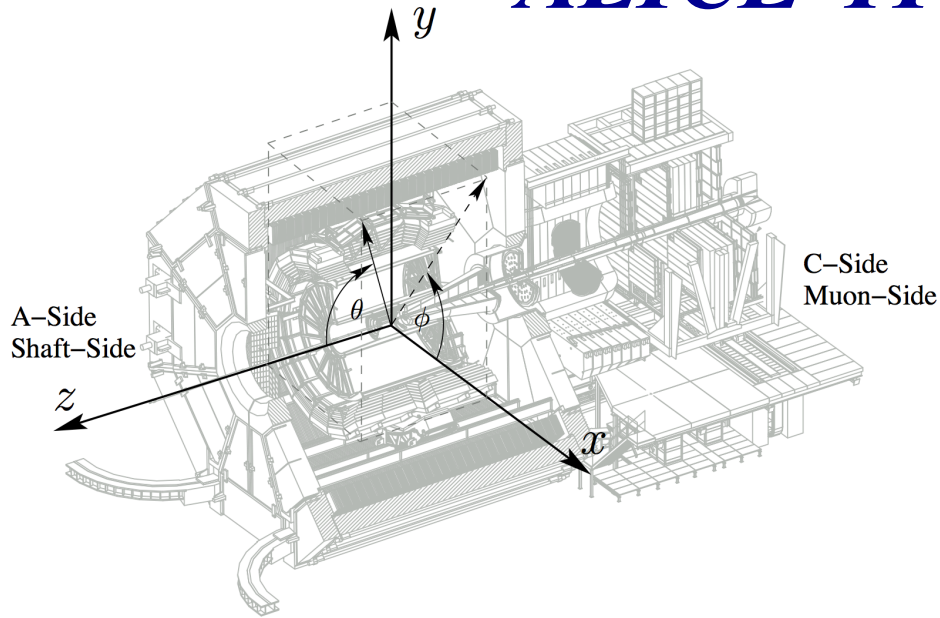

> 9 OROC of ALICE-TPC will be produced in HPD

ALICE-TPC upgrade

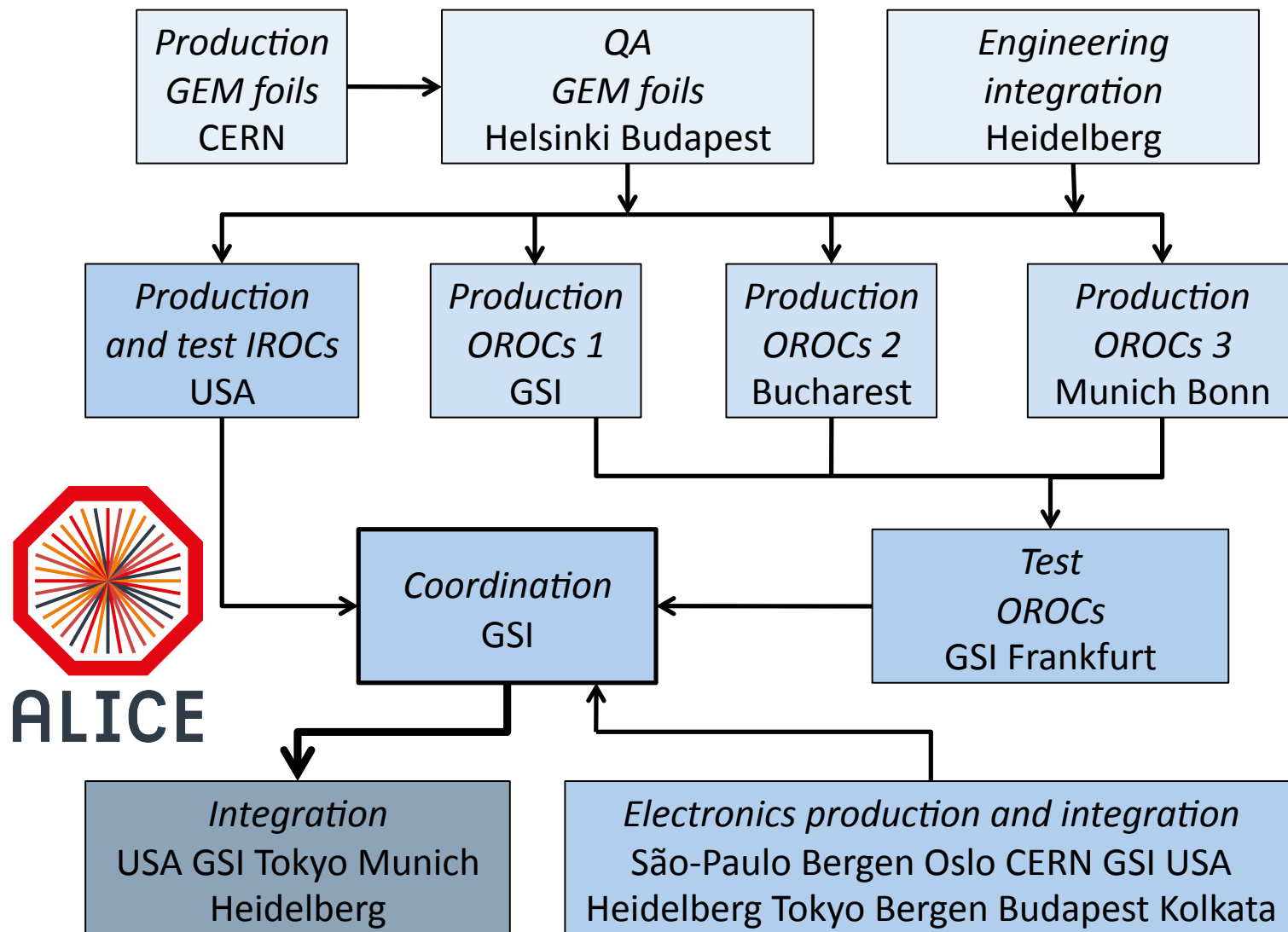

ALICE-TPC upgrade

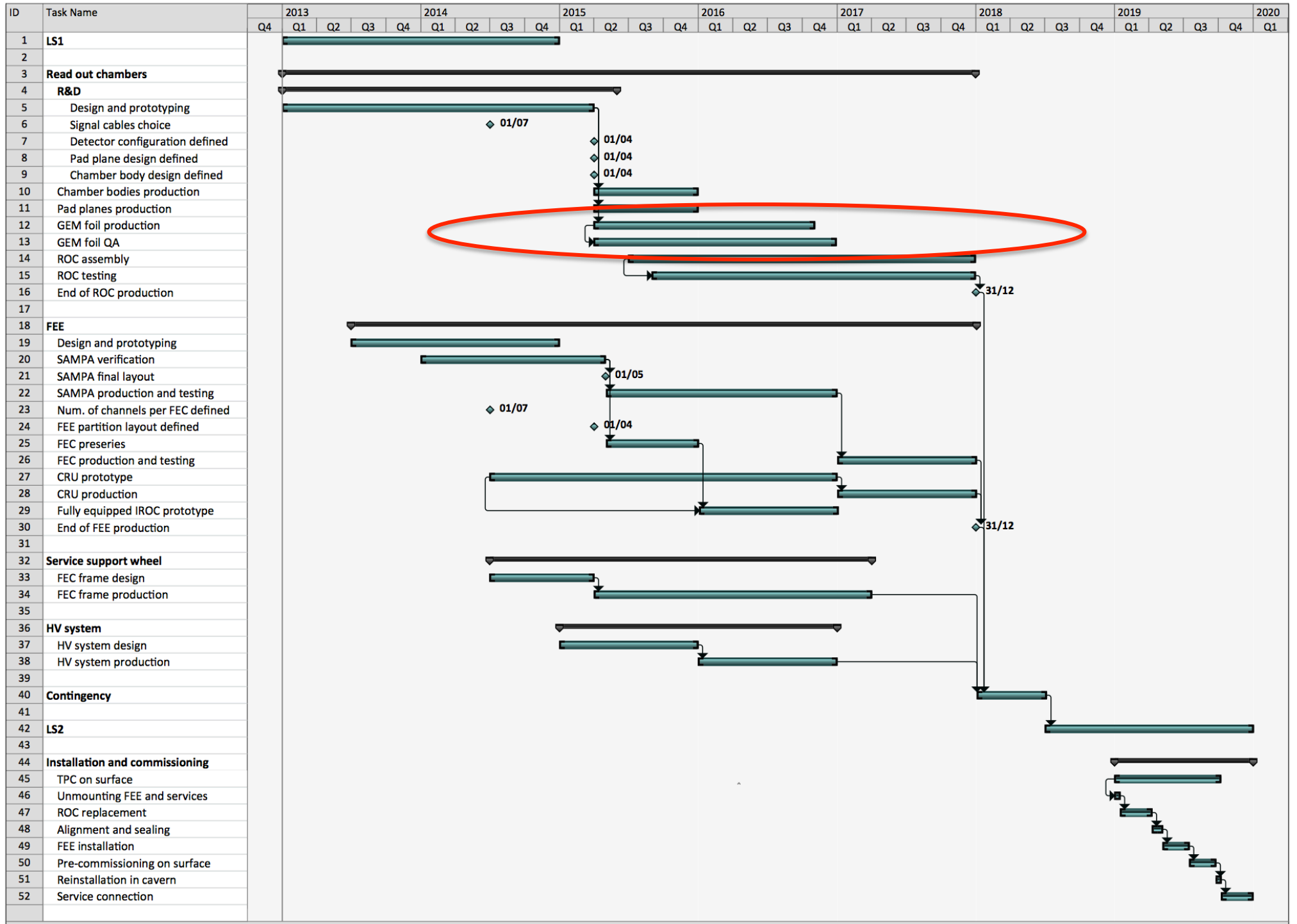

Scientific objectives for the next year

- **The analysis along the lines mentioned above based on Run1 data will be finalized and redone once the new reprocessed data will be available**
- **Substantial statistics will be generated based on EPOS model and comparison with experimental results will be done**
- **The influence of the phase space in which the charged particle multiplicity is selected on the obtained result**
- **Event shape selection based on different event shape global variables**
- **Contribution to the detector operation in Run2**
- **TRD tracking**
- **Operating NIHAM data centre – component of ALICE GRID at its standard efficiency**
- **Service task for PhD students**
- **Setting up the local infrastructure of the Detector Lab**
- **Construction and tests of OROCs based on GEM technology for ALICE-TPC upgrade**
- **Outreach activities**
- **Summer Student Program**
- **Once the new data at the highest LHC energy will become available we will continue our studies at this energy with the hope that the new statistics will give access to extend them at heavy flavor hadrons**

Scientific objectives for the next three years

- **Detailed studies of the dependence of corrections applied to raw spectra on the event shape global variables and their selection power**
- **Follow the same type of analysis applying two dimensional cuts in charged particle multiplicity and event shape**
- **A factor two in the collision energy, soon available at LHC, will enlarge the dynamical range of such studies and the expected higher statistics will give access to extend them at heavy flavor hadrons and compare with the results obtained in A-A collisions**
- **Precise estimates of Bjorken energy density as a function of charged particle multiplicity**
- **Detailed comparisons with PYTHIA, EPOS and other model predictions**
- **Run3 preparations – online tracking**
- **TRD tracking**
- **Operating NIHAM data centre – component of ALICE GRID at its standard efficiency**
- **Construction and tests of OROCs based on GEM technology for ALICE-TPC upgrade**
- **Contribution to the ALICE operation in Run2**
- **Outreach activities**
- **Summer Student Program**



We made it!

Many challenges ahead

Hadron Physics Department

Building A		Building B	
Address	101-1107	Address	101-1107
City	597-110	City	597-110
Country	101-1107	Country	101-1107
Phone	101-1107	Phone	101-1107
Fax	101-1107	Fax	101-1107
E-mail	101-1107	E-mail	101-1107